

Revision Notes:				
R1 - TABLE ADDED TO REPRESENT VARIANTS. DRAWING NAME UPDATED. CONNECTOR DIAGRAMS ADDED.				
APA: E.PANG	Drawn:L.PILLAY	Checked:R.BATES	Approved:B.JOHN	Date: 12/11/2015
R2 - ADDED SPARE PART ITEMS TO TABLE				
APA: E.PANG	Drawn:L.PILLAY	Checked:MPotter	Approved:B.Chlds	Date: 07/12/2015

MODEL NUMBER	PART NUMBER	MODEL/DESCRIPTION
MDR-408-EXP	4898	EXPANSION MODULE WITH GPS AND 64GB SD CARD
MDR-408GW-EXP	5000	EXPANSION MODULE WITH GPS, 3G,WI-FI AND 64GB SD CARD
MDR-408G-EXP	5001	EXPANSION MODULE WITH GPS, 3G AND 64GB SD CARD
MDR-408W-EXP	5002	EXPANSION MODULE WITH GPS, WI-FI AND 64GB SD CARD
MDR-408-EXP-0	5043	EXPANSION MODULE WITH GPS
MDR-408GW-EXP-0	5044	EXPANSION MODULE WITH GPS, 3G AND WI-FI
MDR-408G-EXP-0	5045	EXPANSION MODULE WITH GPS AND 3G
MDR-408W-EXP-0	5046	EXPANSION MODULE WITH GPS AND WI-FI

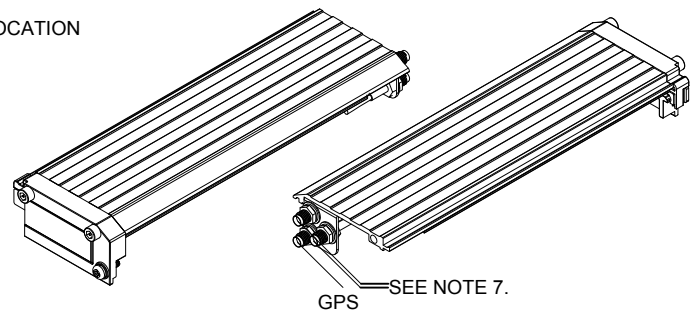

R1 R2

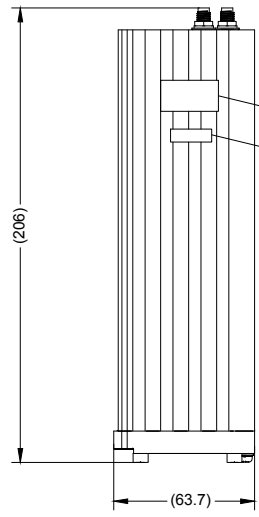
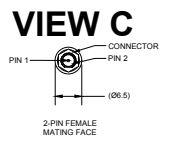
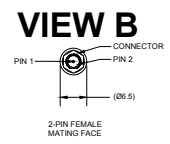
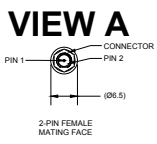
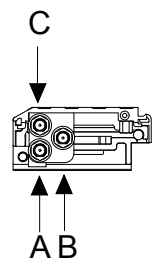
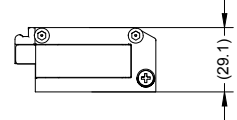
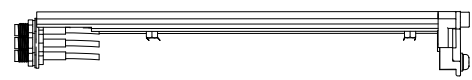

PIN #	DESCRIPTION
1	DATA AND 3V-5V
2	GND

PIN #	DESCRIPTION
1	DATA AND 3V-5V
2	GND

PIN #	DESCRIPTION
1	DATA AND 3V-5V
2	GND

ANTENNA	PART NUMBER	MODEL	DESCRIPTION
(A)	4990	MDR-ANT-WI-FI-01	WI-FI ANTENNA
(B)	4883	MDR-ANT-GPS-01	GPS ANTENNA
(C)	4989	MDR-ANT-3G-01	3G ANTENNA

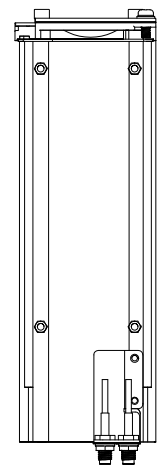

- NOTES:
- THIS DRAWING DOES NOT DEPICT THE INTERNAL PRINTED CIRCUIT BOARD (PCB).
  - ATTENTION: OBSERVE PRECAUTION FOR HANDLING THIS ELECTROSTATIC SENSITIVE DEVICE.
  - REFERENCE INSTRUCTION GUIDE FOR FUNCTIONALITY.
  - FOR PRODUCT LABEL REFER TO LATEST REVISION OF DRAWING: BE-003110-XX-15.
  - FOR SERIAL NUMBER LABEL REFER TO LATEST REVISION OF DRAWING: BE-003112-XX-15.
  - ANY CUSTOMER MODIFICATION OF THIS PRODUCT CAUSING SUBSEQUENT FAILURE IS NOT A LIABILITY OF BRIGADE ELECTRONICS GROUP PLC.
  - 3G AND WIFI CAPABILITIES DEPEND ON MODEL AND AVAILABILITY.
  - A SECURITY ALAN KEY (HEX 3/8" IMPERIAL) IS REQUIRED TO OPEN THIS MODULE TO ACCESS THE SIM CARD.

**PROPRIETARY NOTICE**  
 THIS DESIGN AND TECHNICAL INFORMATION APPEARING ON THIS DRAWING IS THE PROPERTY OF BRIGADE ELECTRONICS, AND IS DISCLOSED IN CONFIDENCE. IT IS NOT TO BE COPIED, REPRODUCED, REVEALED TO OR EXPROPRIATED BY OTHERS, EITHER IN WHOLE OR IN PART WITHOUT THE EXPRESS WRITTEN CONSENT OF BRIGADE ELECTRONICS.



Assembly Pl Approval E.PANG	Approved by B.JOHN	Checked by R.BATES	Drawn by L.PILLAY
Angle of Projection Third Angle	Units mm	Scale N/A	Released 13/11/15
	Status RELEASED	MDR-408XX-EXP	
	Part No VARIOUS	BE-003185-01-15	